

FS500-1200

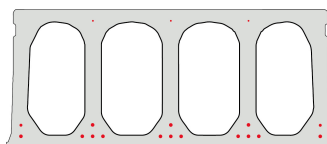

Technische info

Hoogte	500
Breedte	1200
Brandweerstand	1 uur (2u op bestelling)
Milieuklasse	XC1; XC2; XC3 (andere op bestelling)
Transportgewicht	550 kg/m ²
Gewicht/ m	6,60 kN/m
Rekengewicht	5,96 kN/m ²
Kanaalvulling	83,37 l/m
Vulbeton	18,80 l/m ²
Betonkwaliteit	C 50/60
Staalkwaliteit	f(pk) 1860; f(p0,1k) 1580

Overspanningen

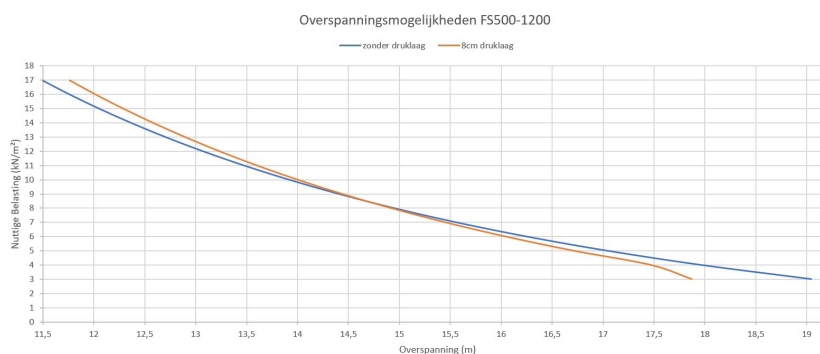

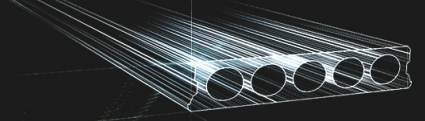

Pasplaten

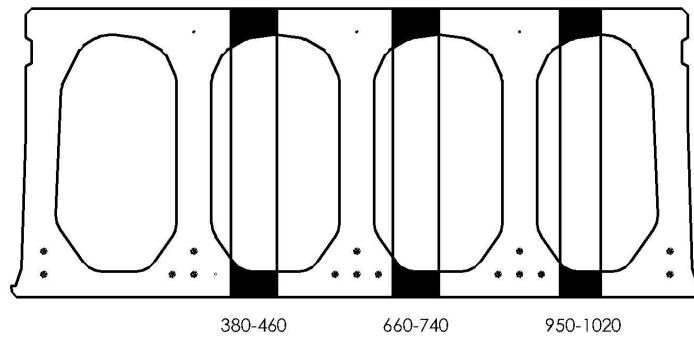

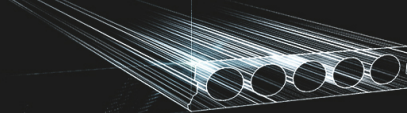

Booradvies

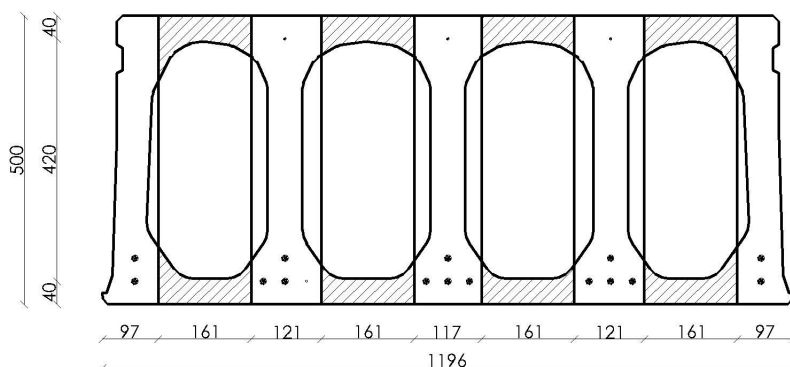

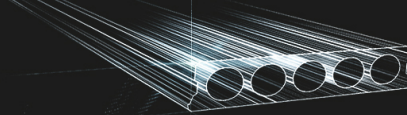

Wapeningspositie

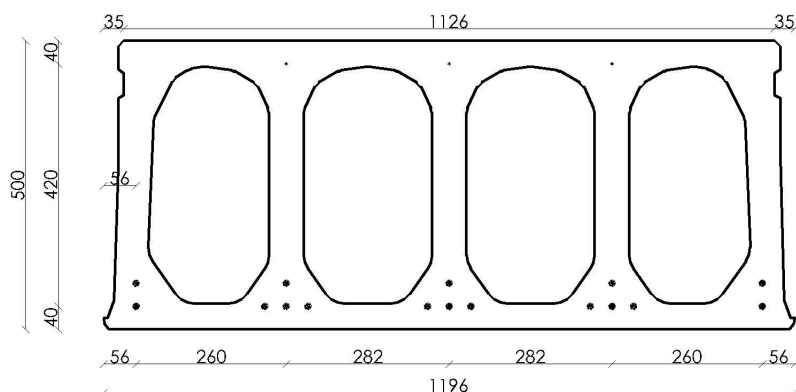

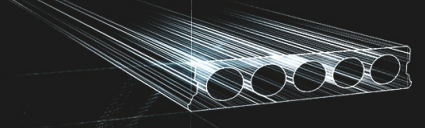

Supplementen

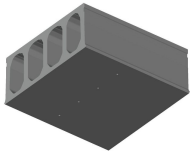

Ontwateringsgaatjes

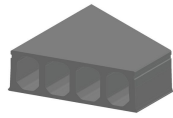

Schuinzagen/inkorten

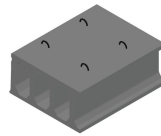

Hijsslussen

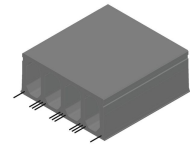

Uitstekende wapening

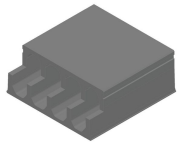

Verdunde bovenzijde

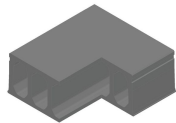

Hoeksparing

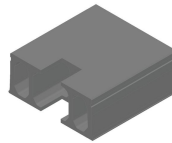

Kopsparing

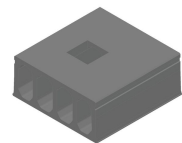

Middensparing

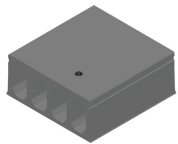

Ronde sparing + CD

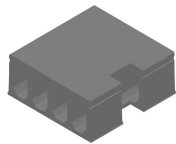

Zijsparing

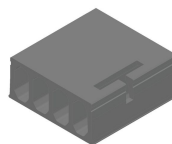

Hamerkop

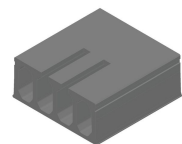

Opengemaakte kanalen

Raveelijzers -
Voorgespannen

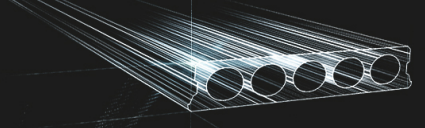

Voorraad

	Productie	Afhaalbaar	Op voorraad
Malle 1			
Malle 2			
Frederickx			
Tessenderlo	X	X	

Gedownload op: 08/06/2020 06:11:46



Fingo
Malle 1 Nijverheidsstraat 21
Malle 2 Industrieweg 22
Malle B-2390
+32 (0)3 309 26 26

Fingo Tessenderlo
Truibroek 76
Ham B-3945

fingo@fingo.be

Fingo - Frederickx
Schuttersveldstraat 11
Messelbroek B-3270
+32 (0)13 78 00 78

pagina 6 / 6